

CAT:	FEET:
------	-------

TYPE:	PROJECT:
-------	----------

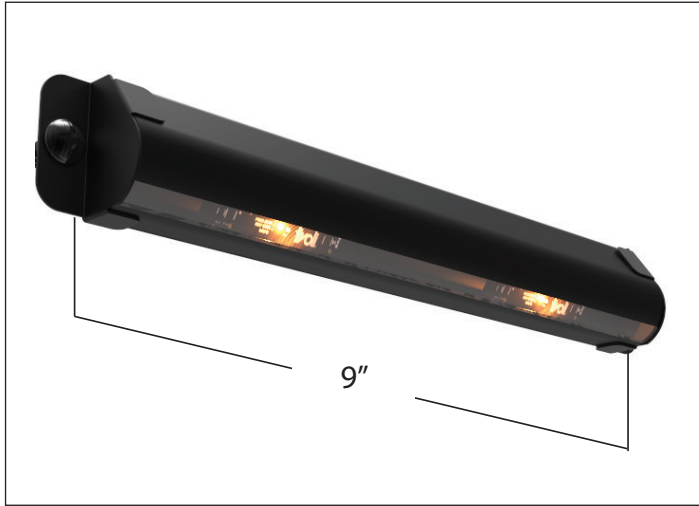

Optically clear polycarbonate co-extruded directional lens features 110° lighting cut-off with no glare intrusive to patrons view.

**Features**

- Compact size 9" x 1 1/4" x 7/8" hidden light source, tamper resistant seat mounted LED lighting system.
- Individually replaceable LED PCBs easily snap into Titanium modules for easy and economical maintenance.
- 48" super-flex conduit standard for wireway connection.
- Use with Tivoli's patented two-tone bullnose stair nosing and wireway with reflective edge to step delineation to maximize voltage drop.

**Mounting**

Usher™ Seat Light is adaptable for stationary non pivot arms, hard or fabric surface mount. Suggested mounting height above floor is 10"-15".

**Applications**

Ideal for seat mounted aisle lighting applications. Seat light is adaptable for stationary or pivot arms, hard or fabric surface-mount.

**Warranty**

5 years



Technical Information

LED Brightness	Low	Standard
*Lumens/ft	21	33
*Watts/unit	0.5	0.7
*Lumen/watt	47	
CRI	>80/TYP83	
Kelvin Temp	1900K, 2700K, 3000K, 3500K, 4000K (+/- 80K) 3SDCM, Red, Blue, Amber	
Rated Life	75,000 hrs.	
Operating Voltage	12V DC	
Power Supply	Class 2	
Dimmable	Yes	

\* 3000K Sample

**Profile Dimensions**

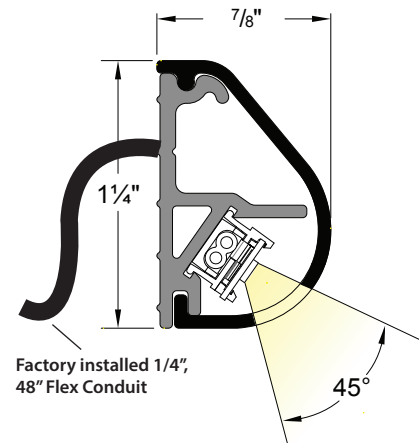

## Recommended Power Supplies

### ADUL - NON DIMMING

DESCRIPTION	CAT NO	APPLICATION	PRIMARY VOLTAGE	SECONDARY VOLTAGE	CIRCUIT BREAKERS	MAX LOAD	CIRCUIT CAPACITY
ADUL Series Class 2 Transformer	ADUL-80-1-5-12-D	Indoor / Damp	100-277V AC 5ø60 HZ	12V DC	1	60W	5A
	ADUL-150-2-5-12-D				2	2x60W	2x5A
	ADUL-240-3-5-12-D				3	3x60W	3x5A
	ADUL-320-4-5-12-D				4	4x60W	4x5A

### ADUL - 0-10V DIMMING

DESCRIPTION	CAT NO	APPLICATION	PRIMARY VOLTAGE	SECONDARY VOLTAGE	CIRCUIT BREAKERS	MAX LOAD	CIRCUIT CAPACITY
ADUL Series Class 2 Transformer	ADUL-80-1-5-12-DOT	Indoor / Damp	100-277V AC 5ø60 HZ	12V DC	1	60W	5A
	ADUL-150-2-5-12-DOT				2	2x60W	2x5A
	ADUL-240-3-5-12-DOT				3	3x60W	3x5A
	ADUL-320-4-5-12-DOT				4	4x60W	4x5A

### ADUL - DMX SINGLE ADDRESS

DESCRIPTION	CAT NO	APPLICATION	PRIMARY VOLTAGE	SECONDARY VOLTAGE	CIRCUIT BREAKERS	MAX LOAD	CIRCUIT CAPACITY
ADUL Series Class 2 Transformer	ADUL-80-1-5-12-DIN	Indoor / Damp	100-277V AC 5ø60 Hz	12V DC	1	60W	5A
	ADUL-150-2-5-12-DIN				2	2x60W	2x5A
	ADUL-240-3-5-12-DIN				3	3x60W	3x5A

### ADUL - DMX MULTI ADDRESS

DESCRIPTION	CAT NO	APPLICATION	PRIMARY VOLTAGE	SECONDARY VOLTAGE	CIRCUIT BREAKERS	MAX LOAD	CIRCUIT CAPACITY
ADUL Series Class 2 Transformer	ADUL-150-2-5-12-DIN-2	Indoor / Damp	100-277V AC 5ø60 Hz	12V DC	2	2x60W	2x5A
	ADUL-240-3-5-12-DIN-3				3	3x60W	3x5A
	ADUL-320-4-5-12-DIN-4				4	4x60W	4x5A

### INFINITY - MLV / ELV / 0-10V / PWM / TRIAC

DESCRIPTION	CAT NO	APPLICATION	PRIMARY VOLTAGE	SECONDARY VOLTAGE	CIRCUIT BREAKERS	MAX LOAD	MIN LOAD	CIRCUIT CAPACITY
Infinity Series Class 2 Transformer	INF-J-30-1-2.5-12	Indoor / Outdoor	100 - 277V AC	12VDC	1	30W	3W	2.5A
	INF-J-60-1-5-12				1	60W	6W	5A
	INF-J-180-3-5-12				3	3x60W	3x6W	3x5A
	INF-J-300-5-5-12				5	5x60W	5x6W	5x5A

## Recommended Dimmers

### DIMMING - 0-10V

DESCRIPTION	CAT NO	APPLICATION	INPUT VOLTAGE	OUTPUT VOLTAGE	MAX LOAD
0-10V Dimmer	DIM-LD-010	Indoor	24V DC	24V DC	30 mA max. output (sink only)

### DIMMING - MLV

DESCRIPTION	CAT NO	APPLICATION	INPUT VOLTAGE	OUTPUT VOLTAGE	MAX LOAD
MLV Dimmer	N-600	Indoor	120V AC	120V AC	450W
	N-1000				800W
	N-1500				1200W
	D-600				450W
	M-600				450W
	M-1000				800W

### DIMMING - ELV

DESCRIPTION	CAT NO	APPLICATION	INPUT VOLTAGE	OUTPUT VOLTAGE	MAX LOAD
ELV Dimmer	ME-600	Indoor	120V AC	120V AC	450W
	DE-300				300W

### DIMMING - DMX

DESCRIPTION	CAT NO	APPLICATION	INPUT VOLTAGE	OUTPUT PROTOCOL	MAX UNIVERSE
DMX Controller	TVOQ-1-WH	Indoor	5V DC	DMX 512	1
	TVOQ-2-BK		6V DC		
	TVOQ-2-WH				
	TVOQ-10-BK-7		6-7V DC		2
	TVOQ-10-WH-7				

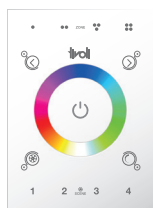

**TVOQ-1-WH**  
WH (White only)

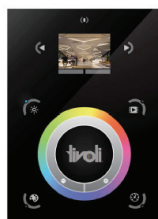

**TVOQ-10-XX-7**  
XX = BK (Black), WH (White)

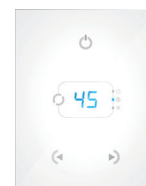

**TVOQ-2-XX**  
XX = BK (Black), WH (White)

## Ordering Information

PRODUCT CODE	FEEDPOINT	LED BOTTOM	NUMBER OF LEDS	FINISH
UST				M
UST = Usher Seat Titanium	C = Center R = Right L = Left	19 = 1900K 27 = 2700K 30 = 3000K 35 = 3500K 40 = 4000K AM = Amber RD = Red BL = Blue	02 = Low Brightness 03 = Standard Brightness	M = Matte

## Mounting Accessories

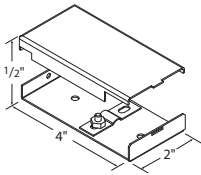

**JBOX-LP**  
Junction box, low profile

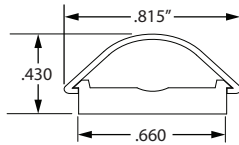

**BS-CC-8**  
Wall wireway, 8' Black Base & Conduit Cover



**BSL-PC-1/4**  
1/4" Flex Conduit, Black

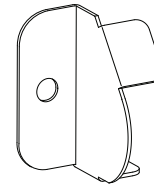

**UTT-EC-L**  
Left End Cap (shown)  
**UTT-EC-R**  
Right End Cap

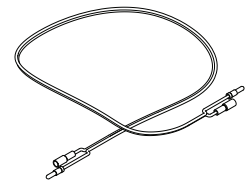

**TTJUMPER2**  
24 inch lead jumper

## Replacement Parts

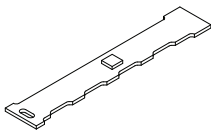

**UTT-LED-19**  
1900K  
**UTT-LED-27**  
2700K  
**UTT-LED-30**  
3000K  
**UTT-LED-35**  
3500K  
**UTT-LED-40**  
4000K  
**UTT-LED-AM**  
Amber  
**UTT-LED-BL**  
Blue  
**UTT-LED-RD**  
Red

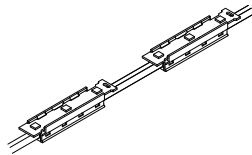

**LOW BRIGHTNESS REPLACEMENT STRAND WITH LEDS**  
**UTT-02-STRAND-19**  
Replacement Strand With 1900K LED  
**UTT-02-STRAND-27**  
Replacement Strand With 2700K LED  
**UTT-02-STRAND-30**  
Replacement Strand With 3000K LED  
**UTT-02-STRAND-35**  
Replacement Strand With 3500K LED  
**UTT-02-STRAND-40**  
Replacement Strand With 4000K LED  
**UTT-02-STRAND-AM**  
Replacement Strand With Amber LED  
**UTT-02-STRAND-BL**  
Replacement Strand With Blue LED  
**UTT-02-STRAND-RD**  
Replacement Strand With Red LED

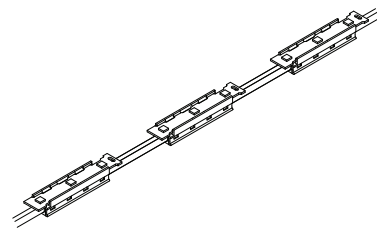

**STANDARD BRIGHTNESS REPLACEMENT STRAND WITH LEDS**  
**UTT-03-STRAND-19**  
Replacement Strand With 1900K LED  
**UTT-03-STRAND-27**  
Replacement Strand With 2700K LED  
**UTT-03-STRAND-30**  
Replacement Strand With 3000K LED  
**UTT-03-STRAND-35**  
Replacement Strand With 3500K LED  
**UTT-03-STRAND-40**  
Replacement Strand With 4000K LED  
**UTT-03-STRAND-AM**  
Replacement Strand With Amber LED  
**UTT-03-STRAND-BL**  
Replacement Strand With Blue LED  
**UTT-03-STRAND-RD**  
Replacement Strand With Red LED

## TwoTone Bullnose & Accessories

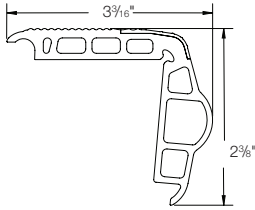

**Bullnose Extrusion**  
**BNS-TT-GY-12**  
 TwoTone Bullnose, 12' length, Black/Gray Strip  
**BNS-TT2-GY-12**  
 TwoTone Bullnose, 12' length, Black/2" Gray Strip  
**BNS-SC-GY-12**  
 Bullnose, Solid Gray, 12' Length

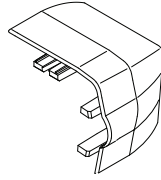

**Bullnose End Caps**  
**BNS-TT-EC-L**  
 End Cap, Left Side Overlap Design, Black  
**BNS-TT-EC-R**  
 End Cap, Right Side Overlap Design, Black

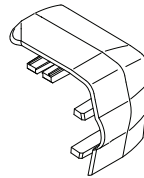

**CC Bullnose End Caps (Carpet-To-Carpet)**  
**BNS-CC-TT-EC-L**  
 End Cap, Carpet-To-Carpet, Left Side, Black  
**BNS-CC-TT-EC-R**  
 End Cap, Carpet-To-Carpet, Right, Black

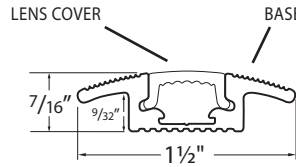

**CC & CW Wire Way Combo - Base & Lens**  
**WW-CC-BK-8**  
 Carpet to Carpet Base and Cover 8' - Black  
**WW-CC-GY-8**  
 Carpet to Carpet Base and Cover 8' - Gray  
**WW-CW-BK-8**  
 Carpet to Wall Base and Cover 8' - Black  
**WW-CW-GY-8**  
 Carpet to Wall Base and Cover 8' - Gray

**CC & CW Wire Way Base ONLY**  
**WW-CW-BS-8**  
 Base Only, Carpet to Wall, Black, 8'  
**WW-CC-BS-8**  
 Base Only, Carpet to Carpet, Black, 8'

**CC & CW Wire Way Lens ONLY**  
**WW-TC-CL-8**  
 Lens Cover Only, Clear, 8'  
**WW-TC-BK-8**  
 Lens Cover Only, Black, 8'  
**WW-TC-BZ-8**  
 Lens Cover Only, Bronze, 8'  
**WW-TC-GY-8**  
 Lens Cover Only, Gray, 8'

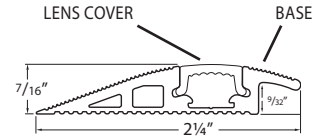

**CE Wire Way Combo - Base & Lens**  
**WW-CE-BK-8**  
 Carpet to Edge Base and Cover 8' - Black  
**WW-CE-GY-8**  
 Carpet to Edge Base and Cover 8' - Gray

**CE Wire Way Base ONLY**  
**WW-CE-BS-8**  
 Base Only, Carpet To Edge, Black, 8'

**CE Wire Way Lens ONLY**  
**WW-TC-CL-8**  
 Lens Cover Only, Clear, 8'  
**WW-TC-BK-8**  
 Lens Cover Only, Black, 8'  
**WW-TC-BZ-8**  
 Lens Cover Only, Bronze, 8'  
**WW-TC-GY-8**  
 Lens Cover Only, Gray, 8'

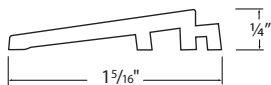

**BNS-TT-R-12**  
 Step Reducer, 12' Section

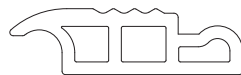

**STP-EXTNDR-12**  
 Bullnose Step Landing Tread Extender, 12'



**ADH-MB-75AM-10**  
 Extrusion adhesive, 10.1 oz tubes, sold individually. 30 per case.  
**ADH-MB-75AM-29**  
 Extrusion adhesive, 29 oz tubes, sold individually. 12 per case.



**ADH-IA-10.2-CA**  
 End Cap Adhesive, Clear liquid adhesive for end caps. 10.2 oz tubes sold individually. 12 per case.

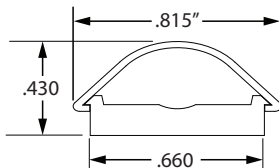

**BS-CC-8**  
 Wall wireway, 8' Black Base & Conduit Cover

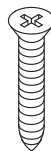

**TM-3/16**  
 Concrete Screw 3/16" x 1 3/4"

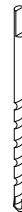

**RONDB-5/32**  
 Concrete Drill Bit 5/32"